

#### A U.S. BLOCK WINDOWS COMPANY

Aluminum Frame		Frame Dimensions				
Series	A	B	C	D	E	F
FL15	2-1/2"	1-1/2"	1"	3/8"	1-9/16"	5/8"
AZ15	2-1/2"	1-1/2"	1-3/8"	3/8"	1-9/16"	5/8"
FL30	3-1/2"	3"	1"	3/8"	1-9/16"	5/8"
AZ30	3-1/2"	3"	1-3/8"	3/8"	1-9/16"	5/8"
FL300	3-1/8"	1-1/2"	N/A	1/2"	1-9/16"	5/8"
Vinyl Frame		Frame Dimensions				
Series	A	B	C	D	E	F
V1500	2-3/8"	1-1/2"	1"	N/A	1-9/16"	5/8"
V1580	2-3/8"	1-1/2"	1-3/8"	N/A	1-9/16"	5/8"
VT200	2-3/4"	1-1/2"	1"	1/2"	1-9/16"	5/8"
V300	3-3/4"	3"	1"	N/A	1-9/16"	5/8"
V380	3-3/4"	3"	1-3/8"	N/A	1-9/16"	5/8"
DISCONTINUED BM1	3-3/4"	1-1/2"	1-1/4"	1-3/8"	1-1/2"	5/8"
VR3000	3-3/4"	1-1/2"	N/A	N/A	1-9/16"	5/8"
VF1500	3-3/4"	1-1/2"	1/4"	1/2" - 1-3/4"	1-9/16"	5/8"
LH1	3-1/4"	1-1/2"	1"	N/A	3-1/16"	7/8"
SHUNG/SLIDER	3-1/4"	3/4"	1-1/4"	N/A	2-1/2"	1-1/2"

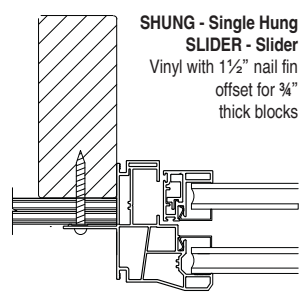
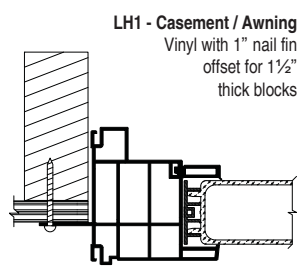
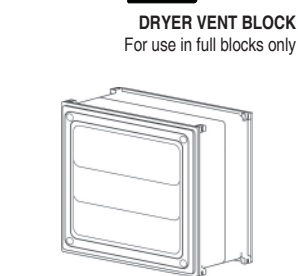
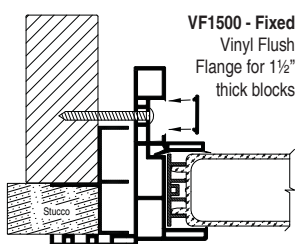
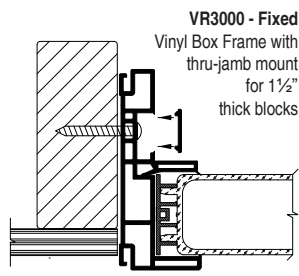
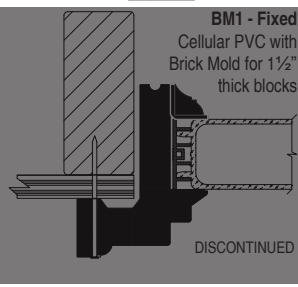
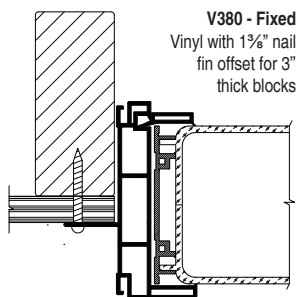
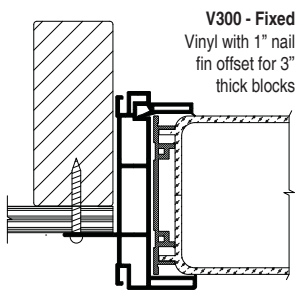
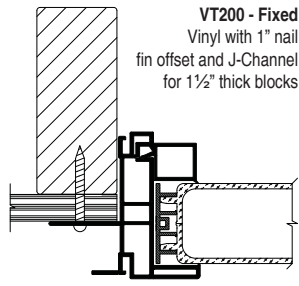
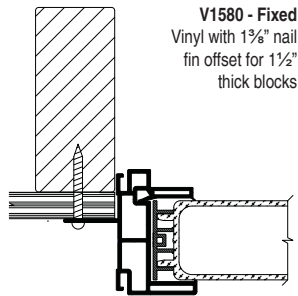
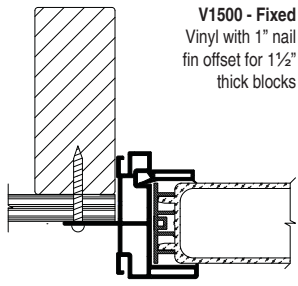
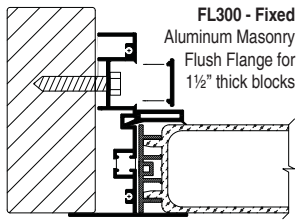
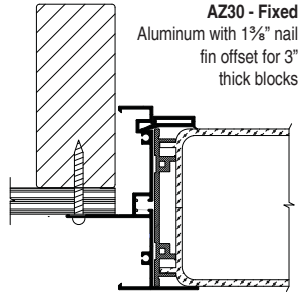
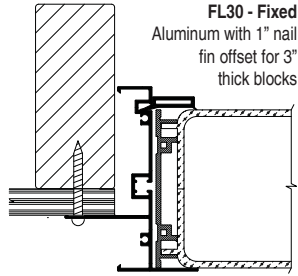
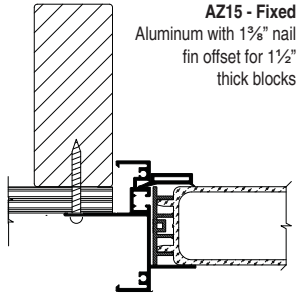
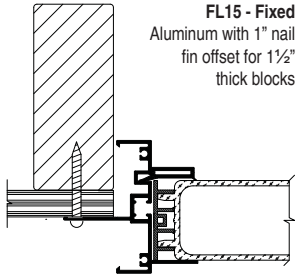
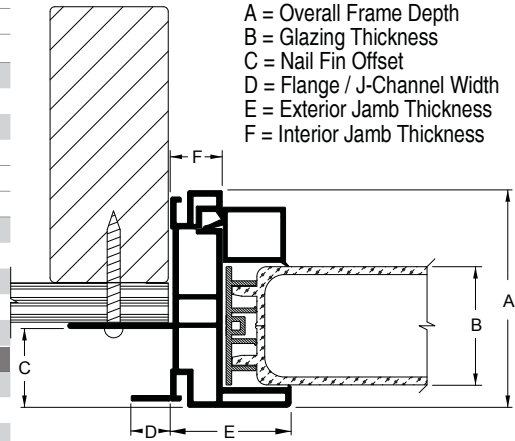

# CLASSIC SERIES

## Frame Drawings & Accessories



A U.S. BLOCK WINDOWS COMPANY

Aluminum Frame Series	Frame Dimensions					
	A	B	C	D	E	F
625/825 - 7/8" Nail Fin Offset	2-1/4"	2"	7/8"	1/2"	5/8"	3/4"
625/825 - 1-3/8" Nail Fin Offset	2-1/4"	2"	1-3/8"	1/2"	5/8"	3/4"
600/800 - 7/8" Nail Fin Offset	3"	2"	1"	1/2"	5/8"	3/4"
Vinyl Frame Series	A	B	C	D	E	F
Prestige II Casement / Awning	3"	2"	1"	N/A	3"	3/4"
Prestige II Fixed	3"	2"	1"	N/A	3"	2"

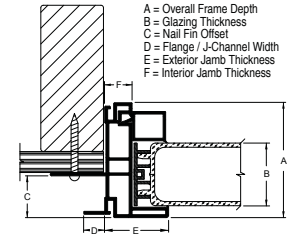

**Aluminum 625/825 Fixed  
7/8" Nail Fin Offset**

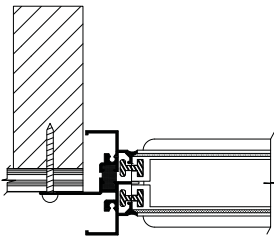

**Aluminum 625/825 Fixed  
1-3/8" Nail Fin Offset**

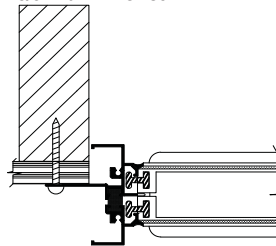

**Aluminum 600/800 Fixed  
7/8" Nail Fin Offset**

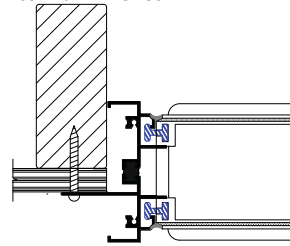

**Vinyl Prestige II  
Casement & Awning  
7/8" Nail Fin Offset**

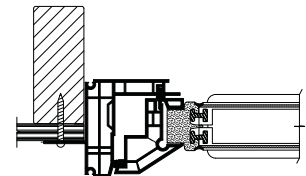

**Vinyl Prestige II  
Fixed  
7/8" Nail Fin Offset**

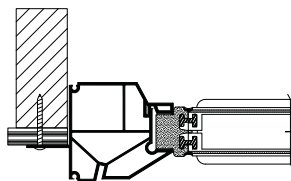

**Special Note on Accessories:**

Prestige II Frame Accessories (UV42, UV22, UV18, UV20, UV09, UV26, UV57 and UV07) are available in White and Tan only and cannot be used with any other frame type listed on this page.

**UV42 - 2-Piece Snap Trim**

One piece fastens to window opening and the other snaps on to cover the fasteners and completes the blind stop.

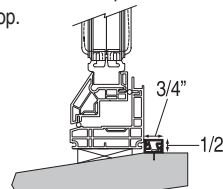

**UV22 - Frame Extender**

Expands frame depth to 3-1/4" and gives the window a 1-3/8" nail fin offset.

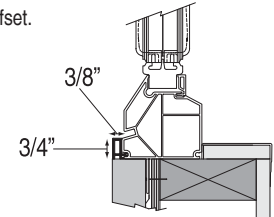

**UV18 - Drywall Return**  
Snaps on interior of frame. Provides channel for drywall.

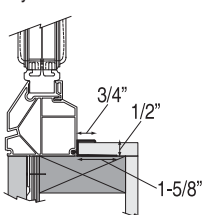

**UV20 - Snap-In Brick Mold**  
Snaps on exterior frame.

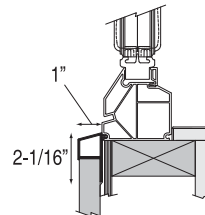

**UV09 - Sill/Jamb Extender**  
Finishes off the exterior gap where window sill meets opening sill. May also be used as jamb extender in some cases.

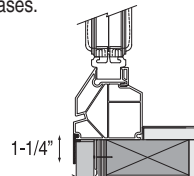

**UV26 - Siding Return**  
Snaps on exterior to cover gap where frame meets siding or other exterior finish. Must be field installed.

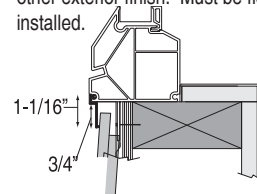

**UV57 - Stucco Flange**  
Snaps on exterior for use as exterior window trim.

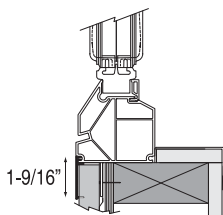

**UV07 - H-Mullion**  
Slides over interior and exterior of window frame. Used to combine groups of windows in one opening.

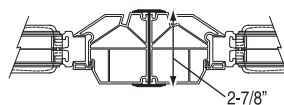

**Dryer Vent Block**  
For use in full blocks only

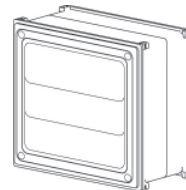

#### A U.S. BLOCK WINDOWS COMPANY

Vinyl Frame Series	Frame Dimensions					
	A	B	C	D	E	F
SHUNG	3-1/8"	3/4"	N/A	N/A	2-1/2"	1"
SLIDER	3-1/8"	3/4"	N/A	N/A	2-1/2"	1"
LH1	3-1/4"	1-1/2"	N/A	N/A	3-1/16"	7/8"
VR3000	3-3/4"	1-1/2"	N/A	N/A	1-9/16"	5/8"
VF1500 Retro	3-3/4"	1-1/2"	N/A	1/2" - 1-3/4"	1-9/16"	5/8"

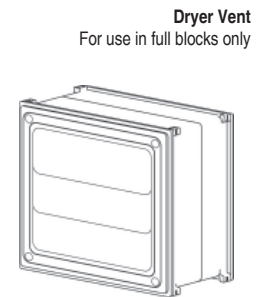
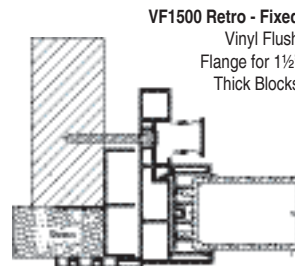
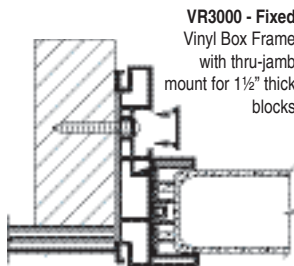
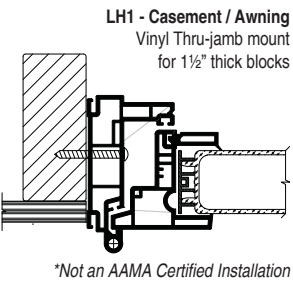
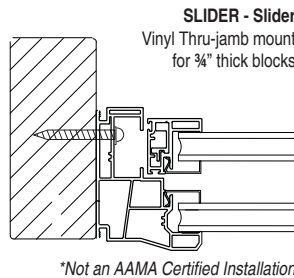
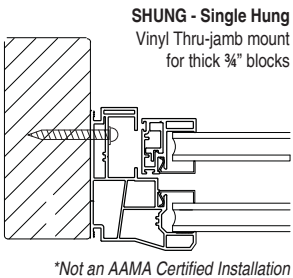
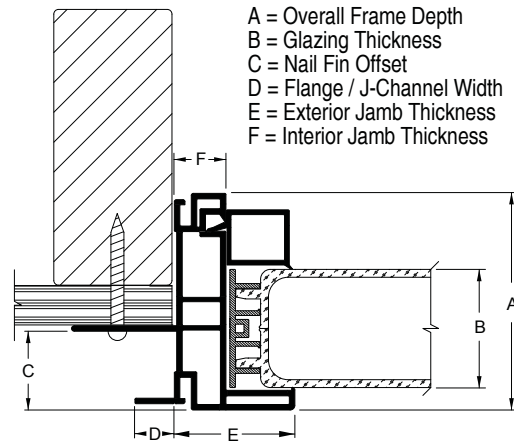

### About Design and Classic Series

#### Design Series & Custom Replacement Series

The Design Series is the premier privacy window line. Featuring a limited lifetime warranty, windows in this series are manufactured with impact-modified acrylic and are designed with cutting-edge innovation for both luxury and durability.

**The majority of U.S. Block Windows' previously-offered products are featured in this series.**

Features of the Design Series include:

- Limited Lifetime Warranty
- Impact-Modified Acrylic
- Extended Style Options

The Custom Replacement Series also falls under this category.

#### Classic Series

The Classic Series is the everyday privacy window line. Featuring a 5 year limited warranty, windows in this series are manufactured with general purpose acrylic and are designed with traditional strength and value in mind.

**The majority of Hy-Lite's previously-offered products are featured in this series.**

Features of the Classic Series include:

- 5 Year Limited Warranty
- General Purpose Acrylic
- Standard Style Options